



WWW.HSPUTELIDS.COM

1300 441 498

Part No: NP12

Fitting Time: 30 mins



NISSAN NP300

HSP TAIL ASSIST

FITTING INSTRUCTIONS

—GENERAL NOTES

- Read through the fitting instructions prior to installation of accessory.
- Ensure all recyclable components and packaging are discarded and recycled following local recycling regulations.
- Safely store and protect any removed vehicle components.

—SAFETY NOTES

- Check that all work practices comply with safety standards.
- Please wear appropriate clothing and use safety equipment.

—FITTING TIME



30 mins

—PARTS SUPPLIED

PART NUMBER	PART DESCRIPTION	QUANTITY
TRS-SPEC-1	Traction strut	1
KSD-SPEC-1	Dampener strut	1
TA-05LH	Tailgate mount l/h	1
TA-05RH	Tailgate mount r/h	1
TA-06LH	Tub mount l/h	1
TA-06RH	Tub mount R/h	1
	<u>Nuts & bolts</u>	
47	M8 x 20mm button socket ss	2
24	M8 thick washer	2
40	M8 nyloc nut	2
	<u>Other</u>	
TR-320	CLEAR PROTECTION TAPE	2
	Alcohol wipe	1

— STEP 1 —

Open tailgate.

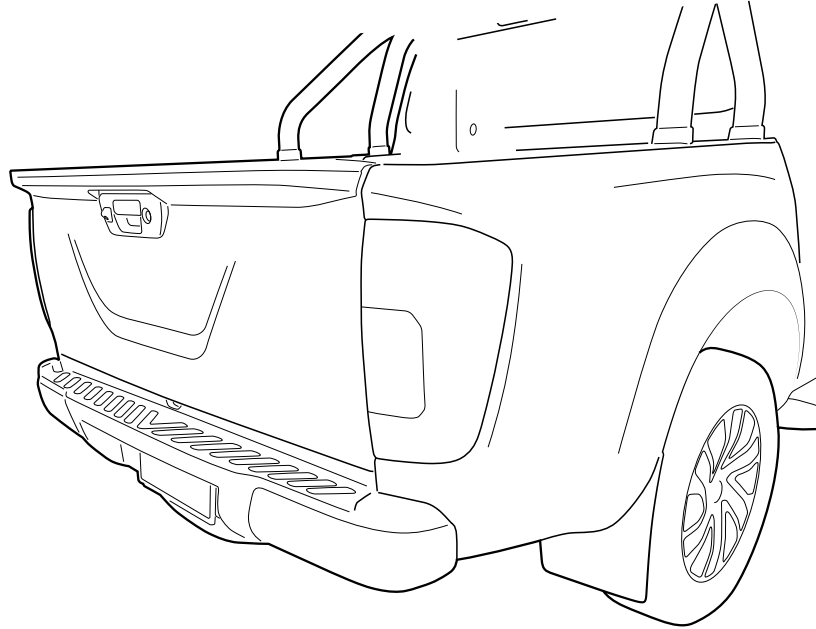

— STEP 2 —

Remove tail light and the indicated bolt (retain bolt) repeat step on the passenger side.

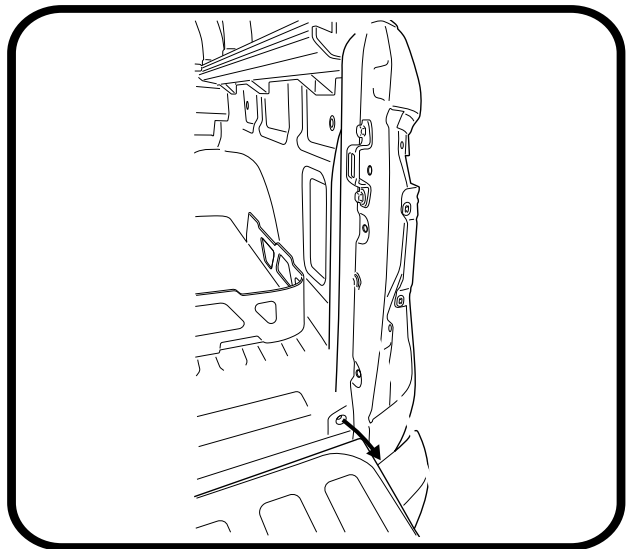
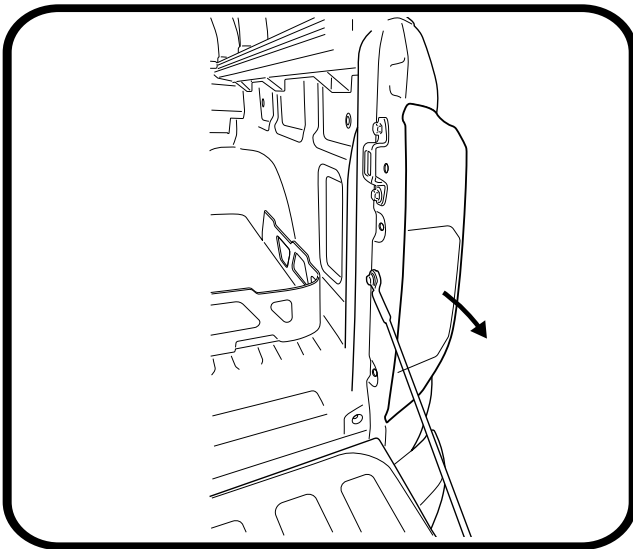

— STEP 3 —

Place part number TA-06RH (Tub mount right hand) as indicated. Using the factory bolt retained, now secure in place.

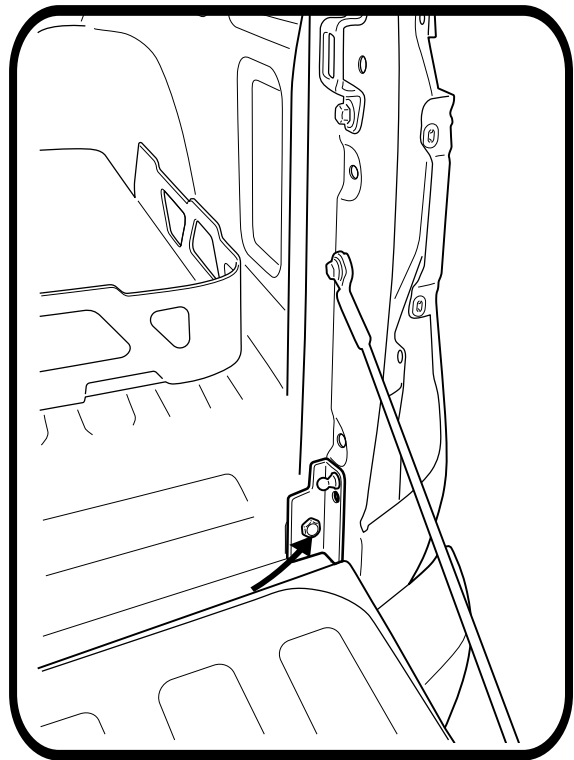
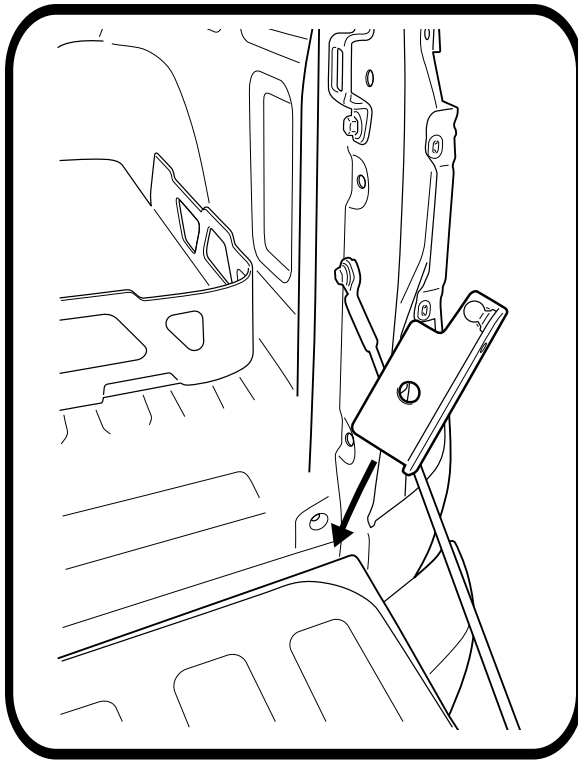

— STEP 4 —

The TA-06RH will have a pre drilled hole. Drill through it into the tub body (using a 8mm drill bit). Clean surface & apply rust inhibitor.

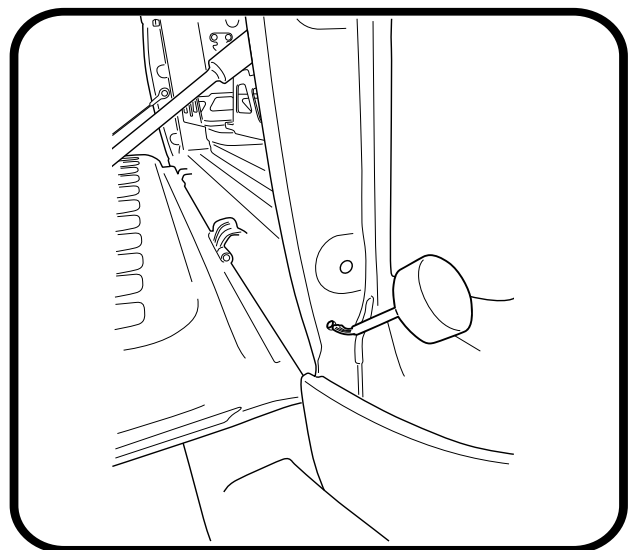
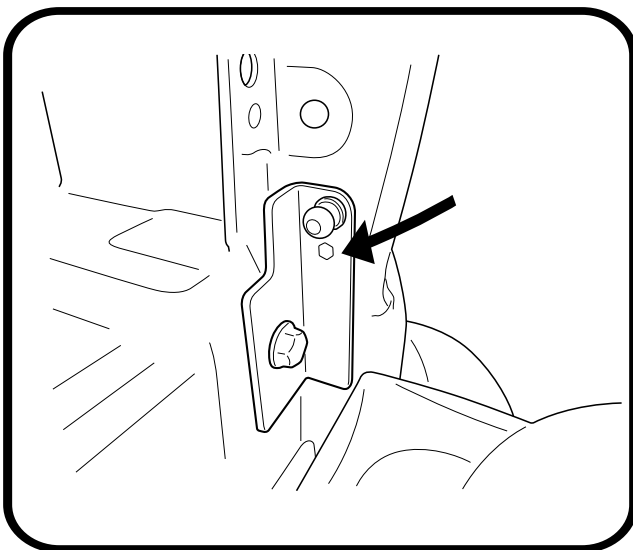

— STEP 5 —

Feed M8 x 20mm button bolt supplied through the bracket and ute body, fasten using the 3mm washer and M8 nyloc nut provided.

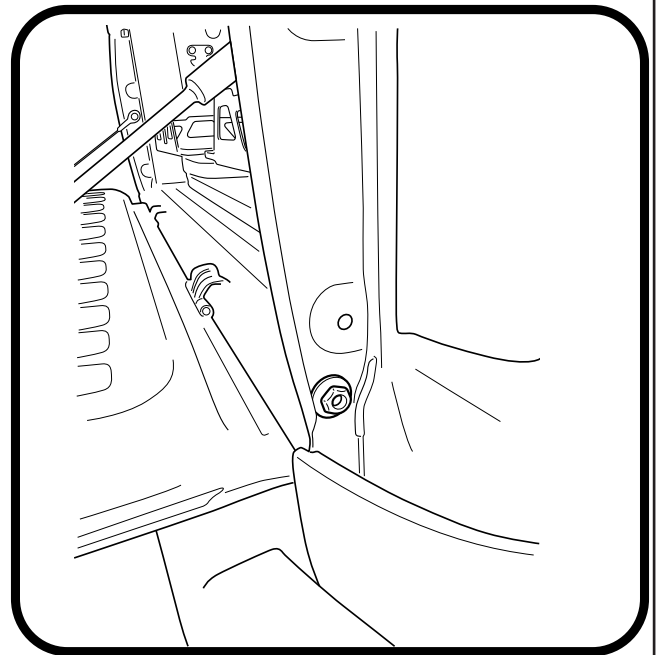
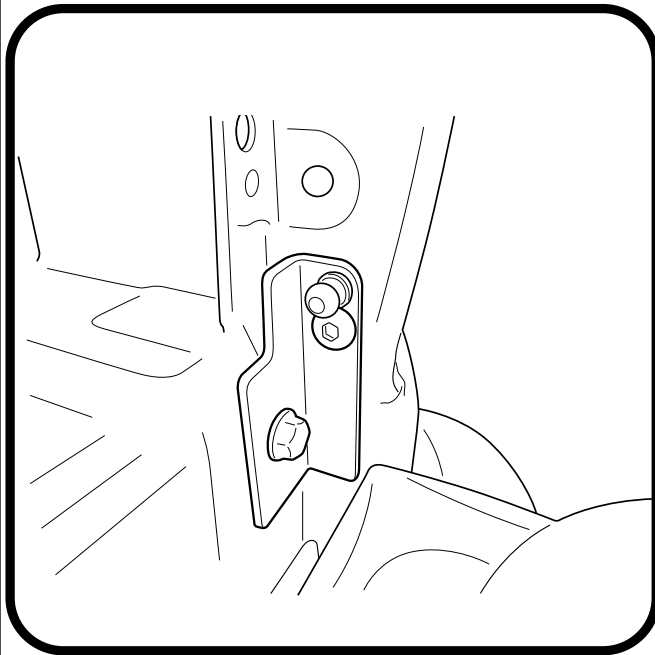

— STEP 6 —

1. Remove indicated bolts and retain.
2. Remove and discard the steel washer, please retain the plastic washer behind it as is.

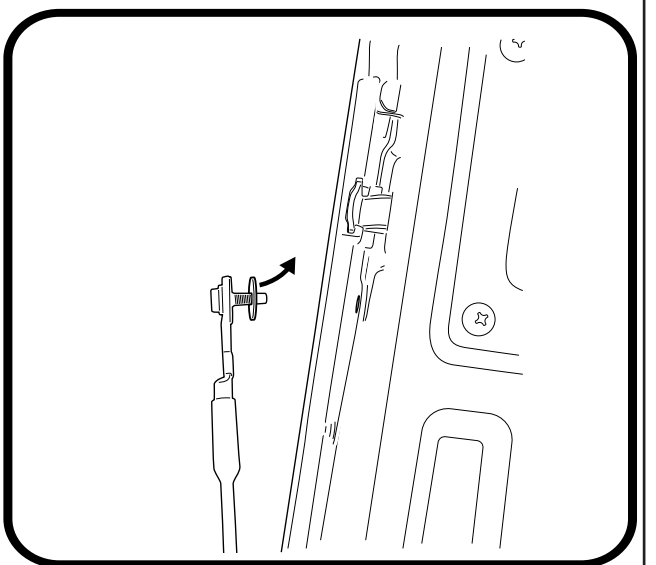
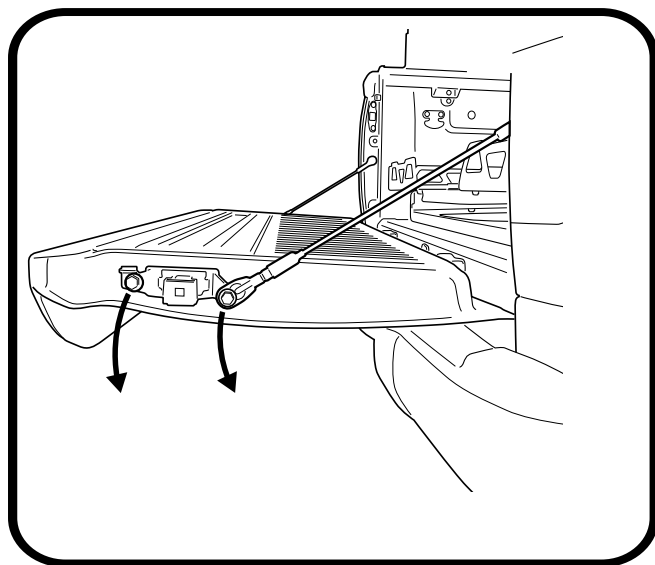

— STEP 7 —

Place TA-05RH as indicated.

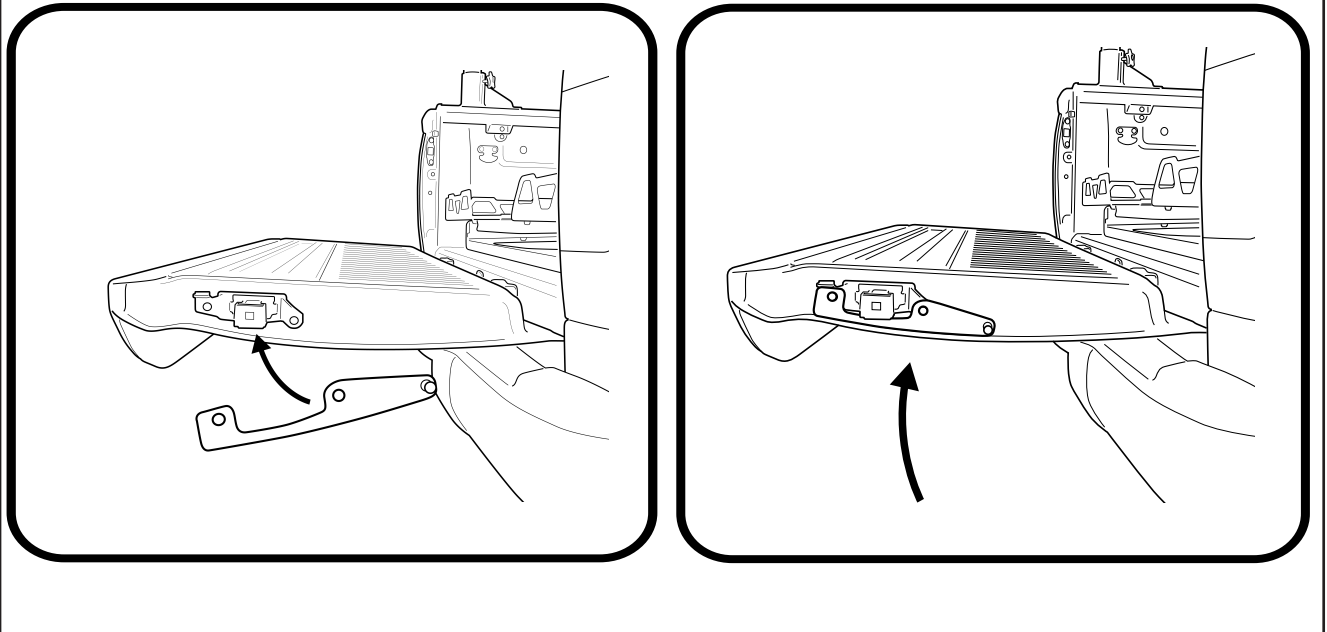

— STEP 8 —

1. Fasten the bracket into place using the retained bolts.
2. Inspect the factory strap making sure it can move freely.
3. Apply clear protection tape (TR-320) as indicated.

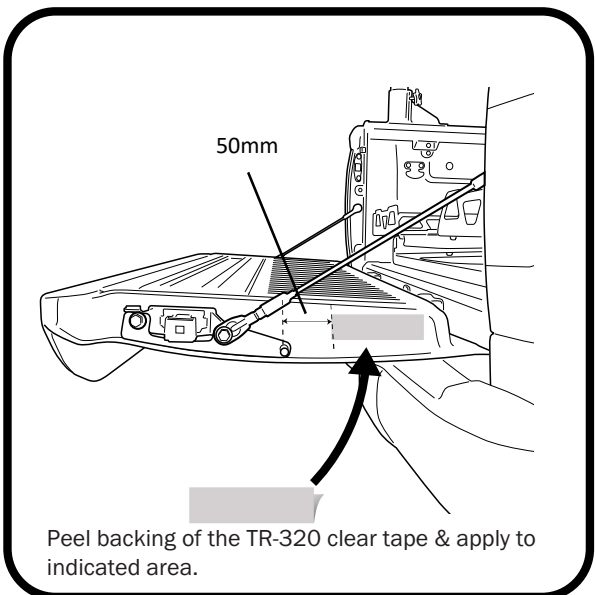
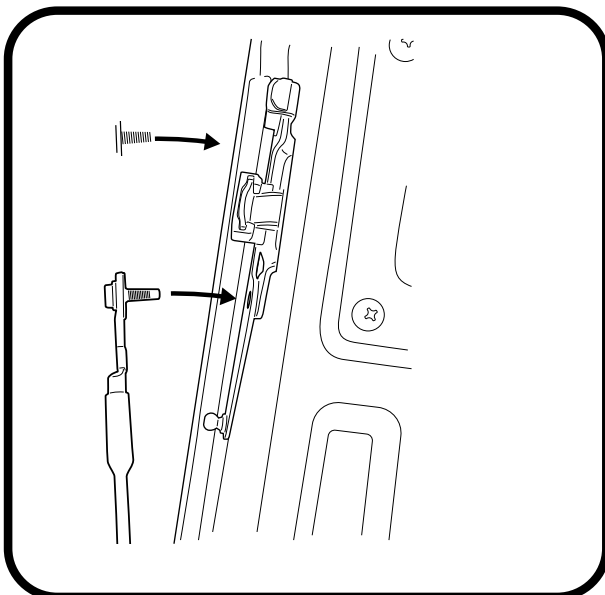

Peel backing of the TR-320 clear tape & apply to indicated area.

— STEP 9 —

1. Connect part number KSD (Dampener strut) as indicated. You will need to pull on the shaft to extend and click in to position.
2. Re-fit the tail light on the drivers side.

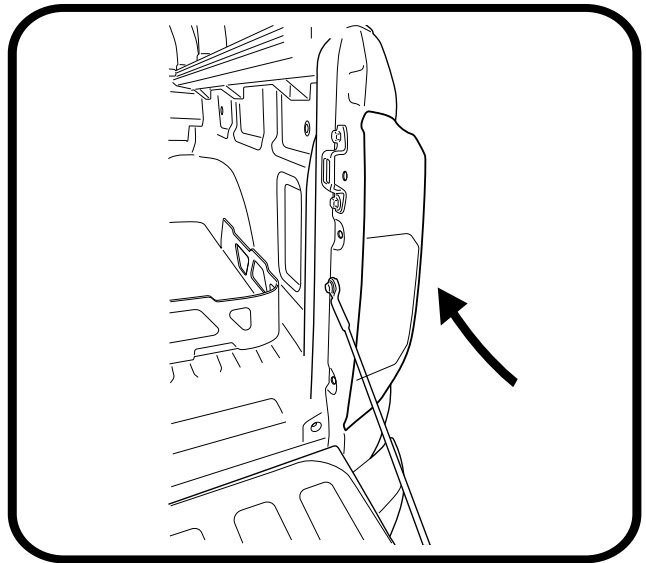
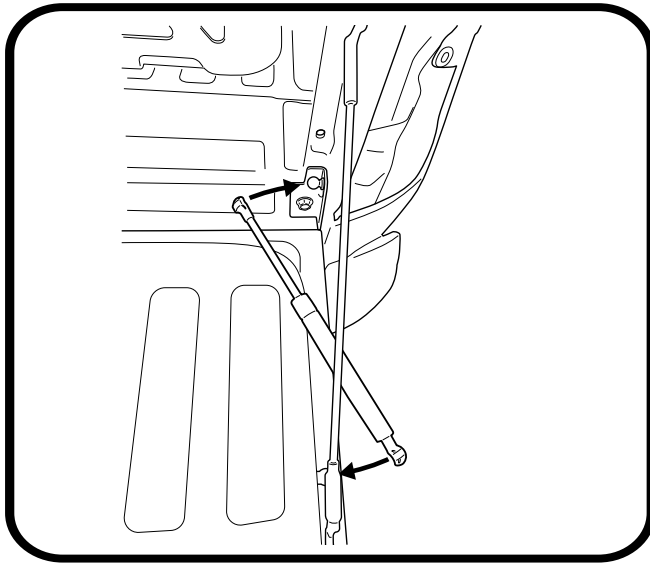

— STEP 10 —

Repeat all the above steps on the passenger side, using TA-05LH & TA06LH.

NOTE: The passenger side Strut has a spacer which will need removing once installed.

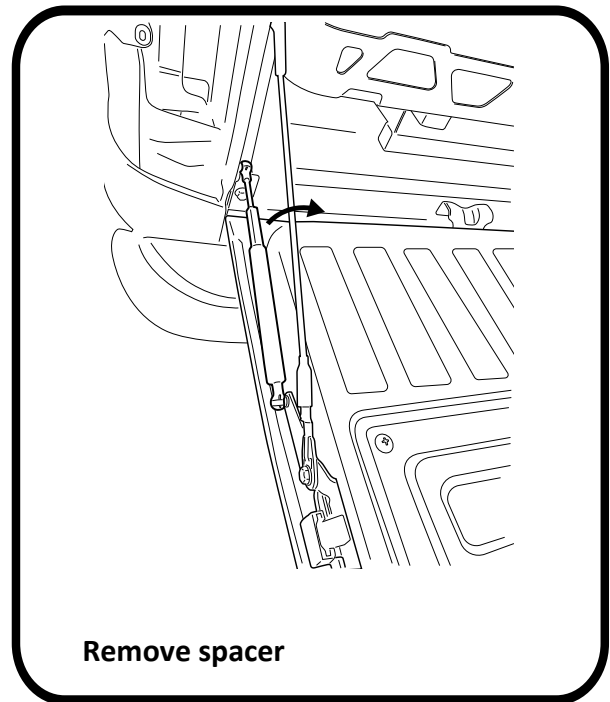
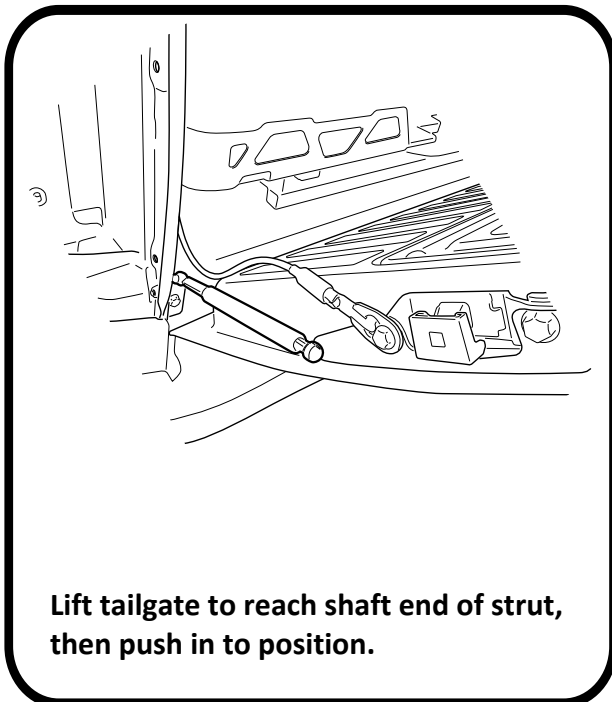

— FITTING COMPLETE —