



KAT #4

VEHICLE SHELVING
the ideal vehicle storage solution

Shelf with Stor Pak 25 Bins

Shelf with Stor Pak 60 Bins

*Shelf with 300mm x 100mm
Spare Part Trays*

*Shelf with 300mm x 200mm
Spare Part Trays*





Shelf position is adjustable with a simple turn of a screw.....





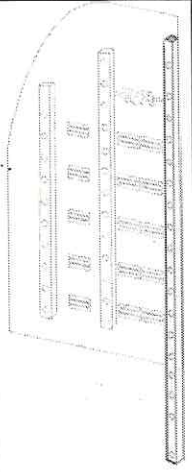
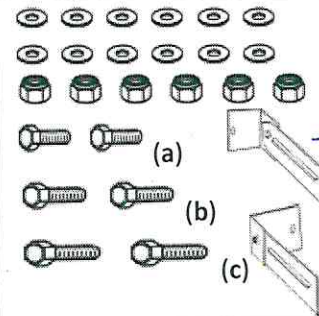
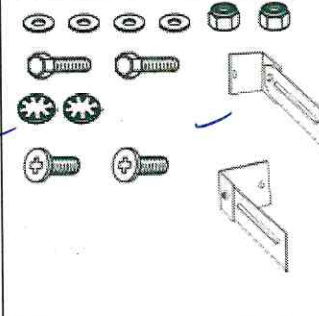

Kit Height	✓
H1 – 860H	
H2 – 1100H	
H3 – 1190H	
H4 – 1240H	✓
H5 – 1300H	
H6 – 1580H	
H7 – 1880H	
Kit Length	✓
Sm – 460L	
Med – 860L	
Lge – 1280L	✓

Thank You for purchasing a KAT Vehicle Shelving System. For this system to perform at it's best it must be assembled and installed as per the attached instructions.

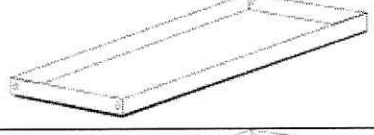

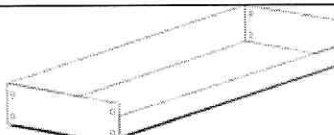
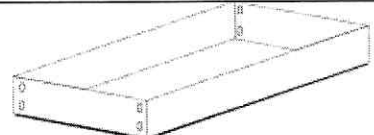
Proudly



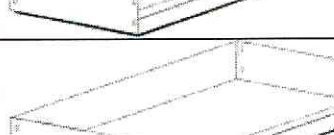
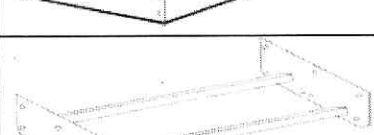
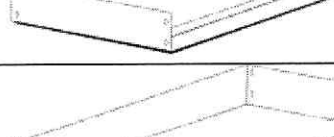
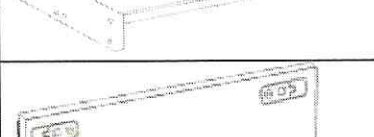



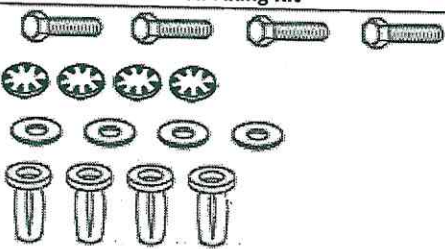
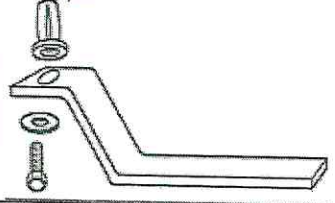
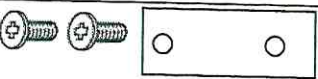



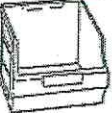
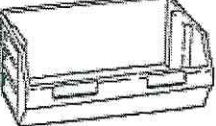
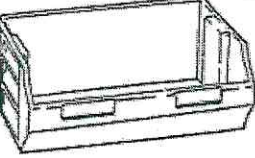
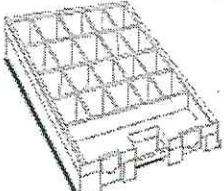

Frame									
End Panel (LH side)	Size	Qty	End Panel (RHside)	Size	Qty	Upper Mounting Bracket Kit	Lower Mounting Bracket Kit		
	1100/365			1100/365					
	1100/430			1100/430					
	1190/365			1190/365					
	1190/430			1190/430					
	1240/365	✓		1240/365	✓				
	1240/430			1240/430					
	1300/365			1300/365					
	1300/430			1300/430					
	1580/365			1580/365					
	1580/430			1580/430					
1880/365		1880/365		Top & Bottom Rail Kit 		Sm			
1880/430		1880/430				Med			
								Lg	✓

Shelves									
Description		Size	Qty	Description		Size	Qty		
	Shelf to hold Stor Pak 10 Bins (S-SP10)	Sm			325mm Open Shelf with 40mm Lip (S-325/40)	Sm			
		Med				Med			
		Lg				Lg			
	Shelf to hold Stor Pak 25 Bins (S-SP25)	Sm			350mm Open Shelf with 40mm Lip (S-350/40)	Sm			
		Med				Med			
		Lg	✓			Lg			
	Shelf to hold Stor Pak 60/120 Bins (S-SP60)	Sm			350mm Open Shelf with 80mm Lip (S-350/80)	Sm			
		Med				Med			
		Lg	✓			Lg			
	Shelf to hold Stor Pak 240 Bins (S-SP240)	Sm			425mm Open Shelf with 40mm Lip (S-425/40)	Sm			
		Med				Med			
		Lg				Lg			
	Shelf to hold 300mm Grey Spare Part Bins (S-325P)	Sm			425mm Open Shelf with 80mm Lip (S-425/80)	Sm			
		Med				Med			
		Lg	2			Lg			
	Shelf to hold 400mm Grey Spare Part Bins (S-425P)	Sm			Cable Reel Holder (Assembly required) S-CRH	Sm			
		Med				Med			
		Lg				Lg			
	Shelf to hold Ezi Pak Carry Cases (S-EZI)	Sm			Single Lockable Door (S-SLD)	Sm			
		Med				Med			
		Lg				Lg			
								Double Lockable Door (S-DLD)	

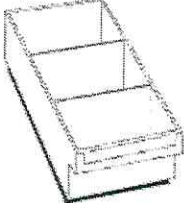
KAT KIT CONTENTS

Fixing Hardware						
Shelf Fixing Kit  (4 per shelf)	Qty	Wall Fixing Kit 		Qty	Nut Insert Tool 	Qty
Joiner Plate Kit 	Qty			1		1
	1				Floor Fixing Kit 	Qty
						1

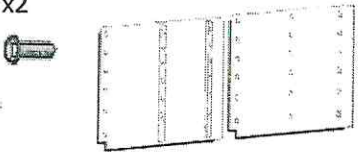
Plastics					
Description		Qty	Description		Qty
	Stor Pak 10			Stor Pak 25 Bin	9
	Stor Pak 60 Bin	6		Stor Pak 120 Bin	
	Stor Pak 240 Bin			Ezi Pak Carry Case	
	300x100x100 Grey Spare Part Bin	12		300x200x100 Grey Spare Part Bin	6
	400x100x100 Grey Spare Part Bin			400x200x100 Grey Spare Part Bin	

Accessories / Options					
Description		Qty	Description		Qty
 x7 Sm Med Lg	Shovel Guard (S-SG)		 x2	Side Panel Extension Kit (S-SPE)	
 Alternate wall fixing kit refer Installation instructions for usage			Professional Installation Kit		

KIT NO: *KAT 4*
 CONTENTS PACKED BY: *JOSL*
 DATE: *24/10/16*

ASSEMBLY INSTRUCTIONS

ATTENTION: PLEASE READ AND UNDERSTAND ALL INSTRUCTIONS AND WARNINGS BEFORE ASSEMBLING, INSTALLING OR USING THIS PRODUCT.



WARNING

These instructions are to be followed using the parts and fasteners supplied for proper installation. Any modifications or improper installation of this product will create a hazardous condition that can cause property damage, serious personal injury or death.

Approximate Assembly Time: 30min
Depending on Shelving Unit purchased

- NOTICE -

Any modifications or variations from instruction and/or unintended use of this product shall immediately void all manufacturer's warranties. Manufacturer disclaims all liability for injuries to persons or property resulting from any modification to, or unintended use of this product.

Tools Required:

- Spanners 1x13mm and 2x11mm
- Phillips Head Screw Driver

- 1** Clear a flat working area and lay out the end panels and top and bottom rails as per *Diagram 1*.

- 2** Lift and hold the left hand end panel so that the front upright is flat on the work area surface. Position the bottom rail on the inside of the upright against the bottom hole and using bolt and washers supplied bolt thru upright into bottom rail. Position top rail against top of upright and bolt thru rail into upright, repeat process with right side end panel. Refer *Diagram 2*

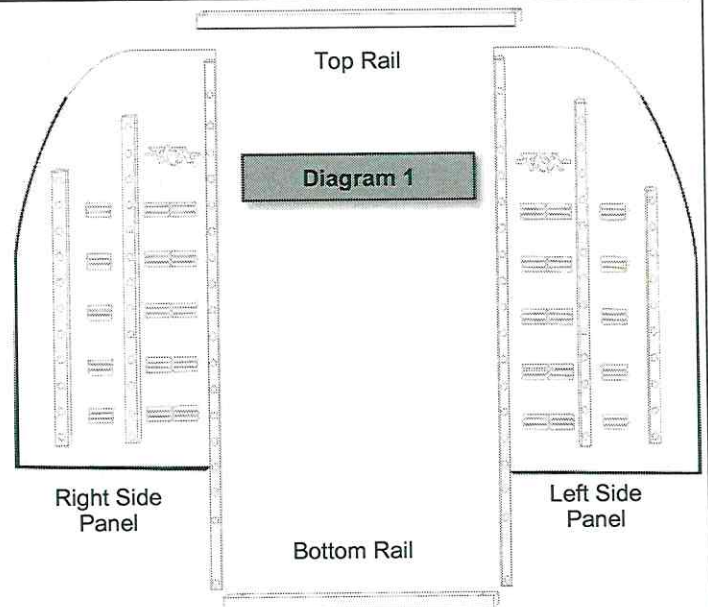
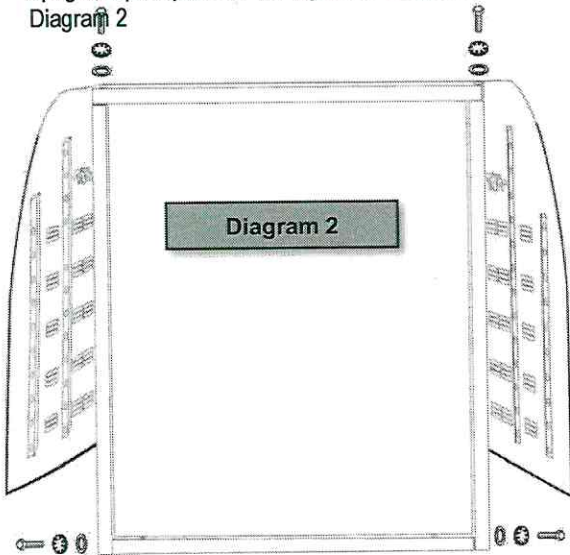

- 3** Assemble the upper mounting brackets as per *Diagram 3* and fit to end panels at top of centre upright (slide between end panel and upright and bolt thru with bolt (c) see *Diagram 4*) Finger tighten only. Put bolts (a) aside for use in installation. Assemble the lower mounting brackets as per *Diagram 3* and screw to rear upright between the 3rd and 4th shelves (*Diagram 4*). Finger tighten only, final position will be determined during installation.

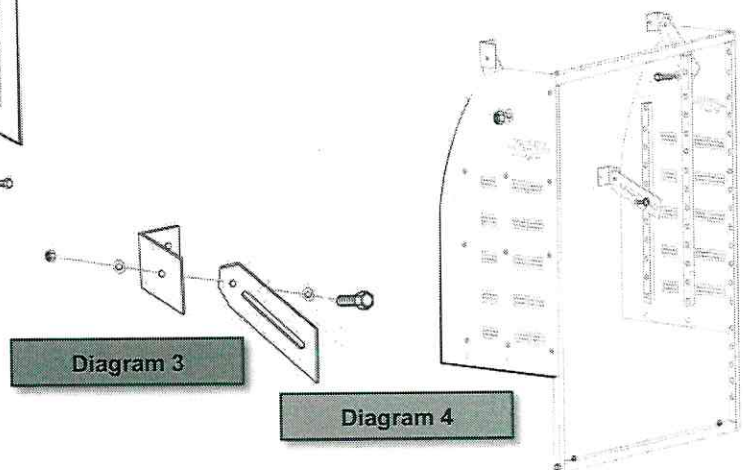

- 4** Using the illustration on the cover page as a guide position and fix shelves into frame, once shelving unit is installed you can easily adjust them up or down to suit your needs. (Some shelves have two holes at each corner these are for extra adjustability only one screw per corner is required).
NOTE: - If the top shelf is to be fitted in the top-most position then discard screw and use upper mounting bracket bolt. (see *Diagram 10* – Installation Instructions)

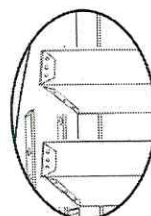

Note: Please ensure when screwing shelves to the frame that the spot welds are facing up. See *Inset*.

HANDY TIP

It is easier to wait until the unit is fitted into your vehicle before putting the plastic bins in their shelves.

CABLE REEL HOLDER

Assemble cable reel holder as per Diagram 5 and fit into frame as a shelf.

LOCKABLE DOOR

Identify and fit the shelf with the lockable door hinge halves pre-attached (the other halves are attached to the door) the shelf above should be positioned so that there is a gap with 2 visible shelf fixing holes.

It will be easier to leave the fitting of the door until after installation is complete.

1 Remove one of the hinge halves from the shelf front and mate to the corresponding half on the door then lift door to mate the other two halves together and reattach hinge half to shelf front.

NOTE – Shelf and door are a 'matched' set so if you have a unit with more than one door check that you are fitting the right door to the right shelf.

If carrying small cable reels - fix back holder here

Diagram 5

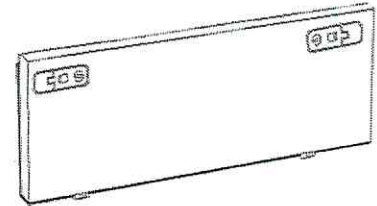
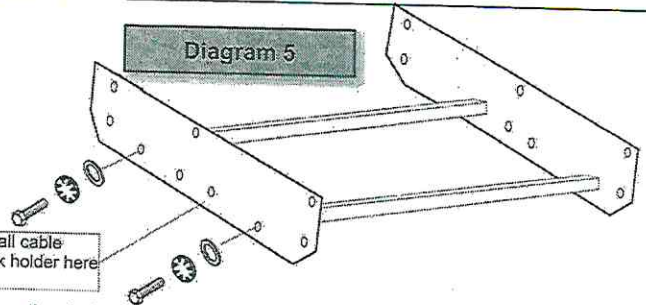

EXTENSION PANLES

These are already attached for you. After completing the installation instructions for your unit, using your drill and the remaining tek screws from packet 2 fix the panels into place using the holes provided on the lip of the extension panels.

Again before drilling check under your vehicle to ensure the position of the drill holes will not affect any part of your vehicle. In some cases it might be necessary to insert the tek screws in another position so they are clear of any parts on your vehicle.

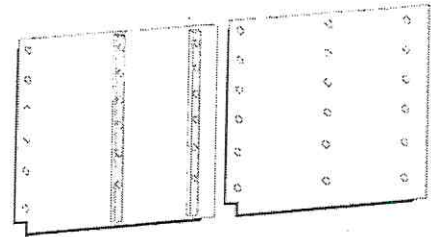

SHOVEL GUARDS

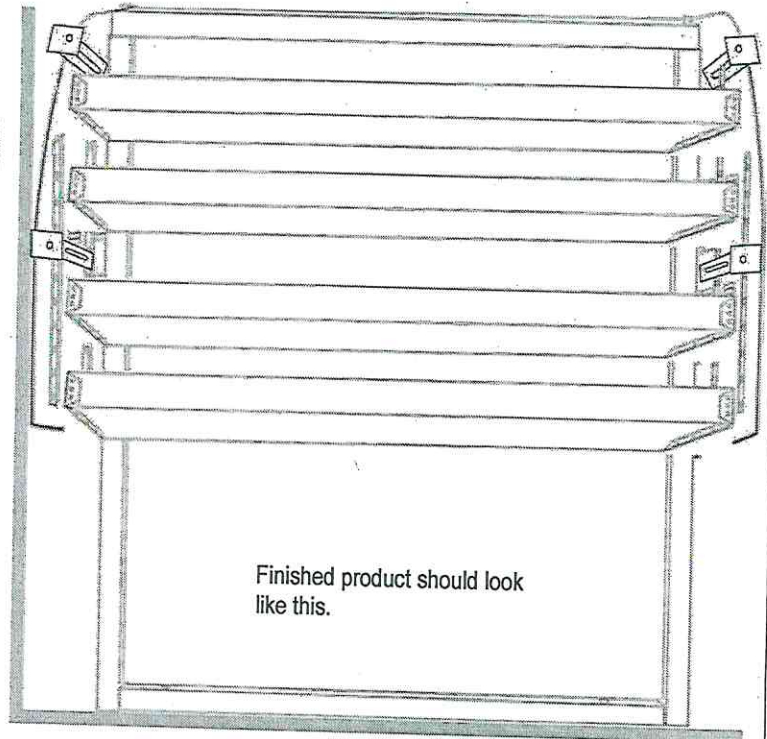
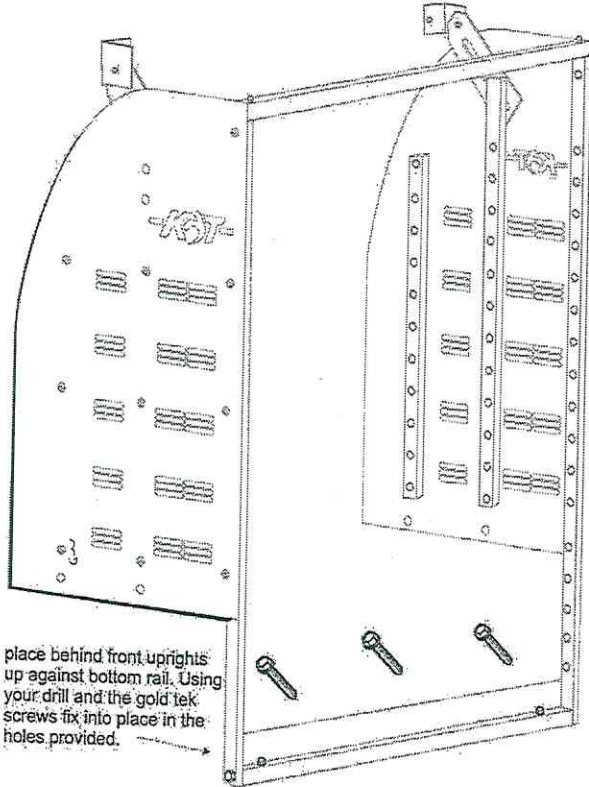

Proudly



IF YOU HAVE ANY QUESTIONS PLEASE PHONE OUR OFFICE ON (07) 3209 9839 FOR ASSISTANCE .

KAT Vehicle Shelving systems are protected by Australian patent 2004100146, 2007100978 and related International patent applications. Registered AU trademark 996358

INSTALLATION INSTRUCTIONS

ATTENTION: PLEASE READ AND UNDERSTAND ALL INSTRUCTIONS AND WARNINGS BEFORE ASSEMBLING, INSTALLING OR USING THIS PRODUCT.



WARNING

- NOTICE -

These instructions are to be followed using the parts and fasteners supplied for proper installation. Any modifications or improper installation of this product will create a hazardous condition that can cause property damage, serious personal injury or death.

Any modifications, variation from instruction or unintended use of this product shall immediately void all manufacturers warranties. Manufacturer disclaims all liability for injuries to persons or property resulting from any modification to, or unintended use of this product.

If you have purchased more than one shelving unit it is advised to use the supplied adaptor plates to secure shelving units together.

Tools Required:

- Electric Drill
- Drill Bits 13/32", 1/8", 1/4"
- 3/8" Hex Tec Bit
- Spanners 11mm x 2
- Black Marking Pen
- Level
- Hammer
- 10mm hex-drive bit

Approximate Installation Time: 30min
Depending on Shelving Unit purchased



WARNING

BEFORE COMMENCING ANY DRILLING INTO YOUR VEHICLE ENSURE YOU CHECK BEHIND OR UNDERNEATH DRILLING AND MOUNTING LOCATIONS, SO AS NOT TO PUNCTURE FUEL TANKS, FUEL LINES, BRAKE LINES, ELECTRIC WIRES ETC



CAUTION

TO KEEP DEBRIS OUT OF YOUR EYES WHEN CHECKING UNDERNEATH YOUR VEHICLE, OR WHEN DRILLING, ALWAYS WEAR PROTECTIVE EYEWEAR

Step 1 – After assembly – Lift unit into vehicle and position where you want it fitted. Make sure you use a level to ensure your unit is straight. If you are fitting more than one unit on one side ensure you leave enough room for second unit to fit.

Check your chosen position to ensure mounting locations are clear of any parts for drilling!

Step 2 – Position upper mounting brackets to the top cant rail of your vehicle, then mark the drill holes with a black pen (*Diagram 1*)

Step 3 – Position lower mounting brackets against the lower cant rail of vehicle (change position of mounting bracket up or down the end panel upright as necessary) mark the drill holes with a black pen.

Step 4 – Check that all four bracket holes and pen marks line up then move shelving unit to one side.

Step 5 – Using a drill with a spacer (so as not to drill through the external wall of vehicle). Drill one 10.5mm hole for each wall bracket. (*Diagram 2*)

Step 6 – Using a hammer tap in all four nut inserts (wall fixing kit) (*Diagram 3*)

Step 7 – Remove sample set up from nut insert tool, place bolt and washer through the nut insert tool as per sample set up and with a 10mm hex-Drive bit tighten the bolt until nut insert has fully collapsed and anchored to the wall. (*Diagram 4 & 5*)

Step 8 – Remove bolt/washer and tooling so you are left with just the blind fastener. (*Diagram 6*) Repeat step 7 & 8 for all blind fasteners.

Step 9 – Lift unit back into position and using the lock and flat washers bolt mounting brackets into nut inserts. (*Diagram 7*)

Step 10 – Using your level check that the unit is straight. Then tighten all nuts and bolts and screws.

Step 11 – Using the 2 supplied 45mm tec screws (floor fixing kit) screw unit to floor thru predrilled holes in the bottom rail. (*Diagram 8*)

Step 12 – Using bolt (a) from upper mounting bracket kit lock upper bracket to end panel by drilling and bolting thru bracket slot. (*Diagrams 9 & 10*)

Repeat above steps if you are fitting more then one unit to your vehicle – ensuring to use Joiner Plate Kit if fitting next to each other.

Before drilling double check that the position of the pre drilled holes is clear of any vehicle parts under your vehicle!

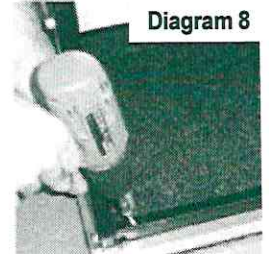
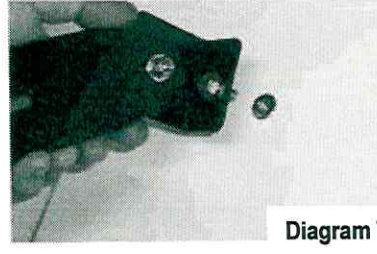
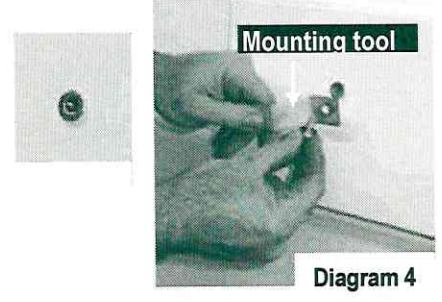
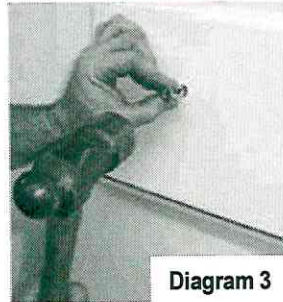
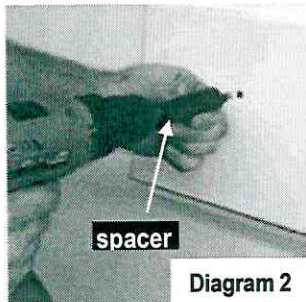

**** This step must be completed to ensure warranty is not voided****

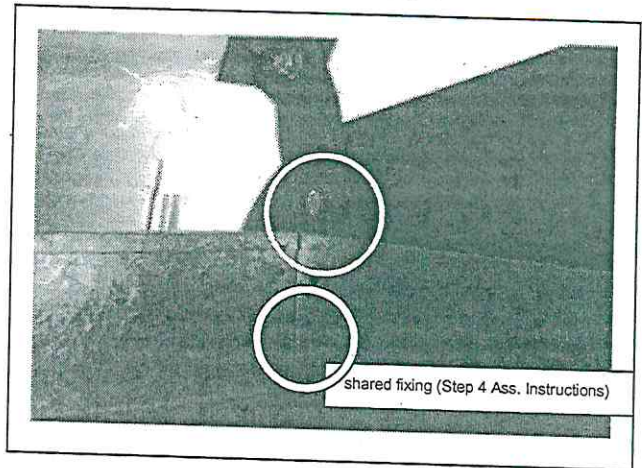
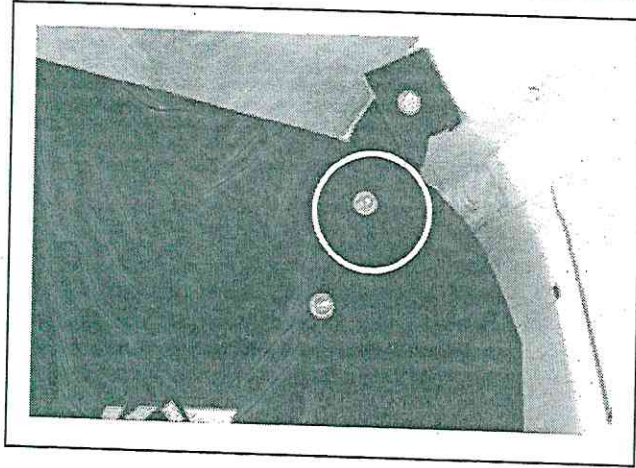

Outside view – Diagram 9

Inside view – Diagram 10

Alternate wall fixing – in some vans there are a number of unused “factory mounting points” (captured nuts) which may be conveniently located and may be used instead and drilling and nut inserting. Or it may be necessary to share a mounting point with another fitting i.e. cargo barrier upper mounting bracket. In some cases it may not be possible or practicable to use the nut inserts (extra thick or double layer material at a join or lack of space behind or close proximity to sliding door channel or similar working mechanism, in which case a 20mm self-drilling Tec-screw (Alternate Wall Fixing Kit) may be used. Do Not pre-drill Do Not over-tighten (over-tightening will strip thread and render useless) KAT Vehicle Shelving strongly recommends the proper use of the supplied nut inserts as the preferred method of fixing the wall brackets and advices that the installer give due and careful consideration to the appropriateness and strength of an alternative method before proceeding. KAT also recommends regular checking of all fasteners for tightness and security.

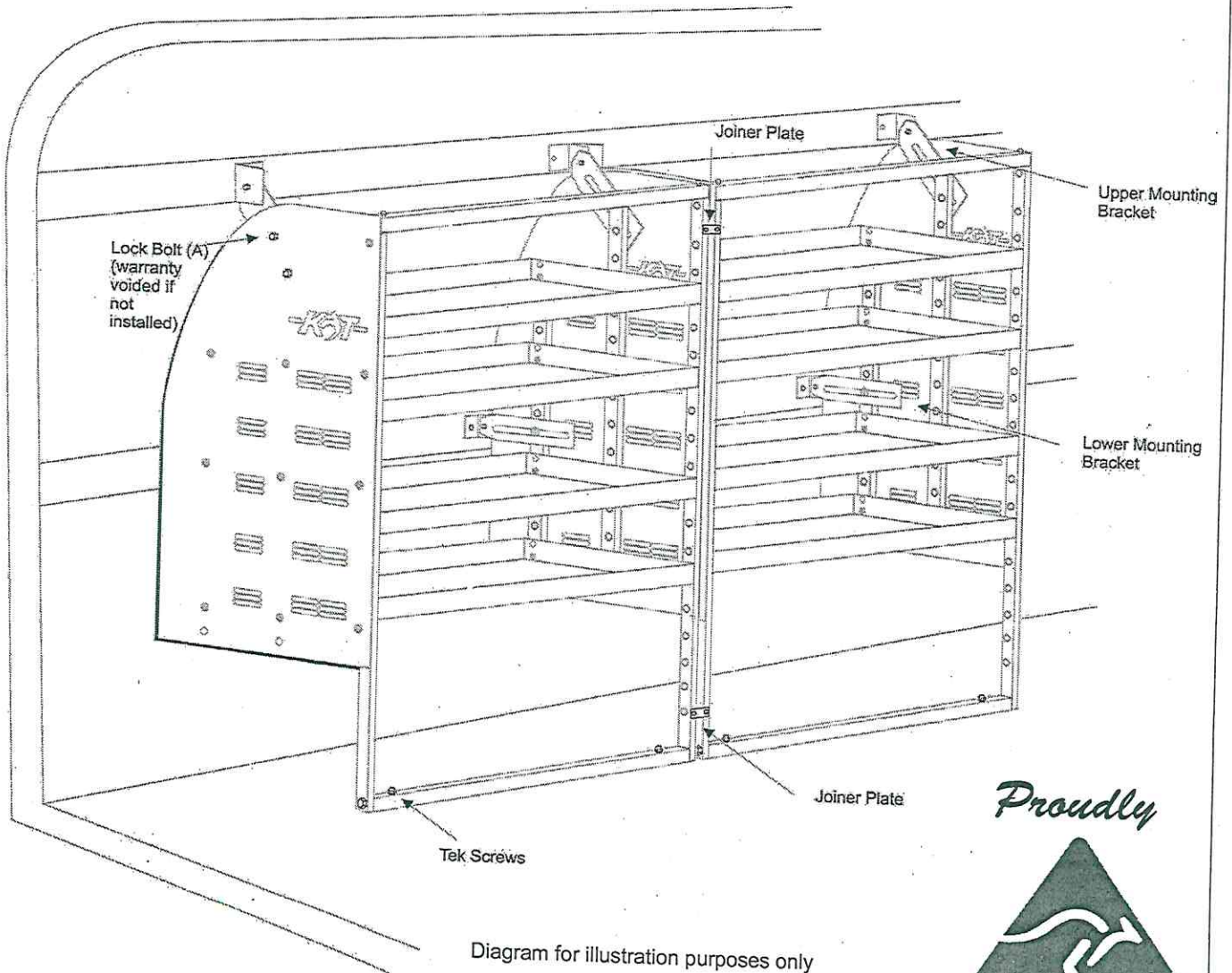

Diagram for illustration purposes only



IF YOU HAVE ANY QUESTIONS PLEASE CONTACT OUR OFFICE ON (07) 3209 9839

KAT Vehicle Shelving systems are protected by Australian patent 2004100146, 2007100978 and related International patent applications. Registered AU trademark 996358